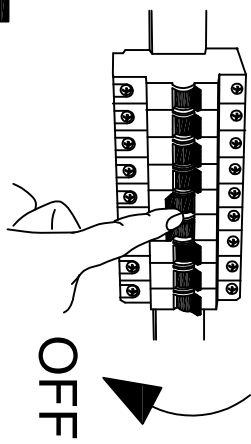
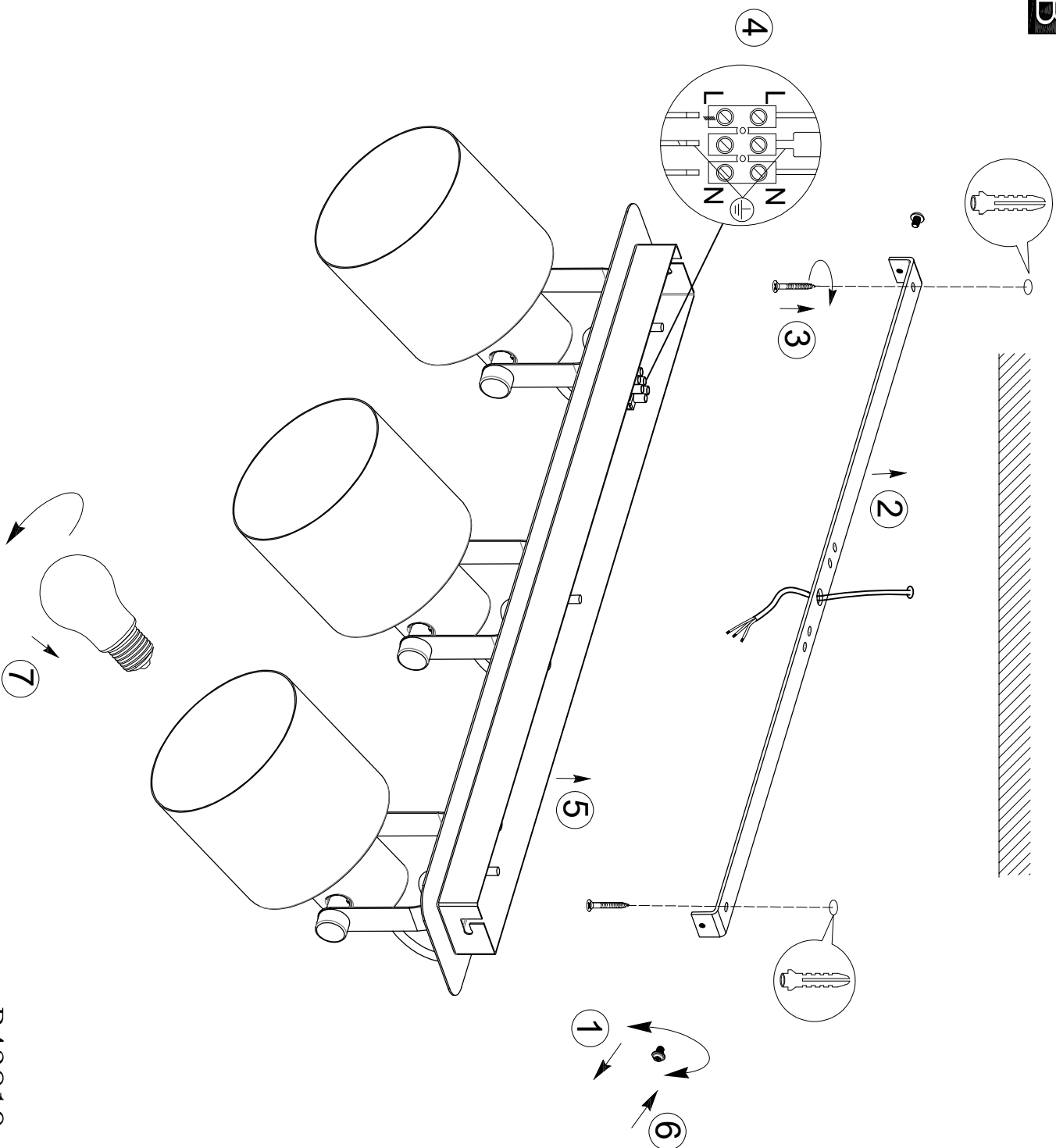
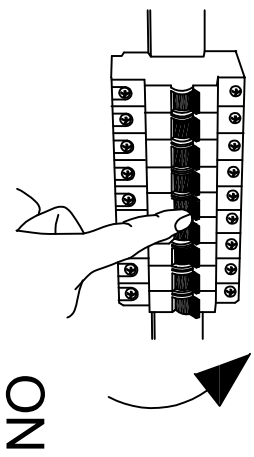

**A****B****C**

B43819  
www.eglo.com